

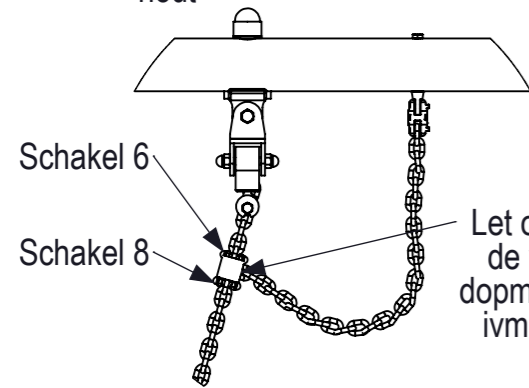

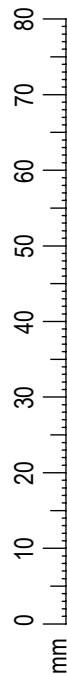



Voetenplan



Let op! Boven en onder de veiligheidsketting dopmoeren en draadeind ivm. vingerbeknelling.

DETAIL A
SCALE 1 : 10

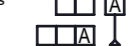

| | | | | | | | | | |
|---|--|--|---|--|--|-------------------------|--------------|------------|------------|
|  IJSLANDER IJslander BV Oude Dijk 10 8096 RK Oldebroek The Netherlands T +31 (0)525 633420 F +31 (0)525 631067 info@ijslander.com www.ijslander.com | oppervlakte ruwheid surface roughness DIN ISO 1302  | alg. ruwheid gen. roughness  | eenheid/unit cm | datum date 10-2-2025 | naam name SK | | | | |
| | vorm- en plaatstoleranties geometrical tolerancing DIN ISO 1101  | toelaatbare afwijkingen voor lineaire maten (m.u.v. gebroken kanten) admissible deviations for linear dimensions (excepting broken edges) | | | | | | | |
| alg. toleranties gen. tolerancing DIN 7168-m | lineaire maat linear dimension afwijking/deviation | > 0,5 ≤ 0,1 | 6 ±0,2 | 30 ±0,3 | 120 ±0,5 | 400 ±0,8 | 1000 ±1,2 | 2000 ±2 | 4000 ±3 |
| proj.  | omschrijving/description Kupa Max Enkele schommel 1x vogelnest | | Totaal gewicht: 424 kg Zwaarste onderdeel: 90 kg | Leeftijd van: 3 - 12 jaar Valondergrond klasse: B - Minimaal natuurlijke bodem benodigd | tekeningnummer/drawingnumber CS-1-GS07-H-R05-INS 8 - 49 05 | blad/sheet A3 | | | |
| schaal/scale 1:50 | | | | | | | | | |