

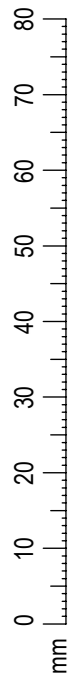

 IJSLANDER IJslander BV Oude Dijk 10 8096 RK Oldebroek The Netherlands T +31 (0)525 633420 F +31 (0)525 631067 info@ijslander.com www.ijslander.com	oppervlakte ruwheid surface roughness DIN ISO 1302	alg. ruwheid gen. roughness 3.2	eenheid/unit cm	datum date 22-12-2017	naam name TB
	vorm- en plaatstoleranties geometrical tolerancing DIN ISO 1101	toelaatbare afwijkingen voor lineaire maten (m.u.v. gebroken kanten) admissible deviations for linear dimensions (excepting broken edges)			
alg. toleranties gen. tolerancing DIN 7168-m	lineaire maat linear dimension afwijking/deviation	> 0,5 ≤ 6	6 30 120	120 400 1000	2000 4000 8000
proj. 	omschrijving/description Click & Play Basketbalpaal oefenmodel polycarbonaat bord	Totaal gewicht: 60395.45 kg	Zwaarste onderdeel: 38 kg	Leeftijd van: 5 - 99 jaar	Valondergrond klasse:
schaal/scale 1:20	tekeningnummer/drawingnumber CP-1180-PC-R01-INS	blad/sheet 3 - 4	wijz./rev. 01	form./size A3	

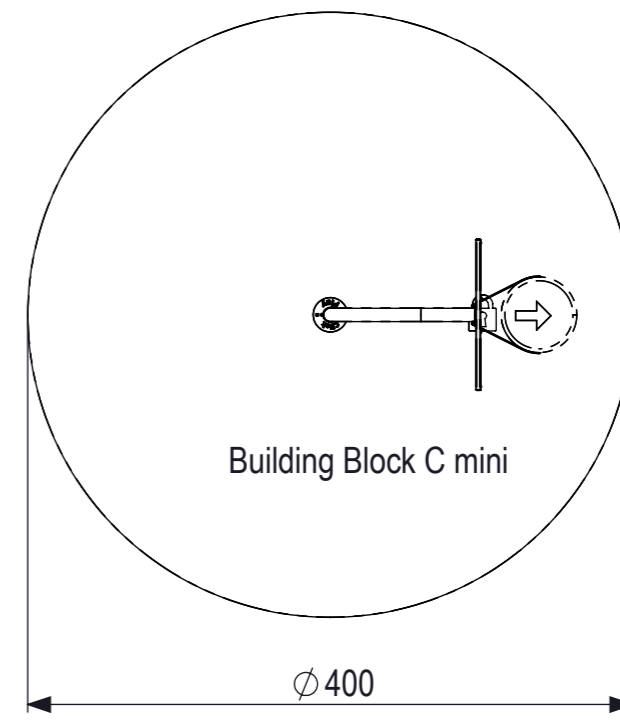
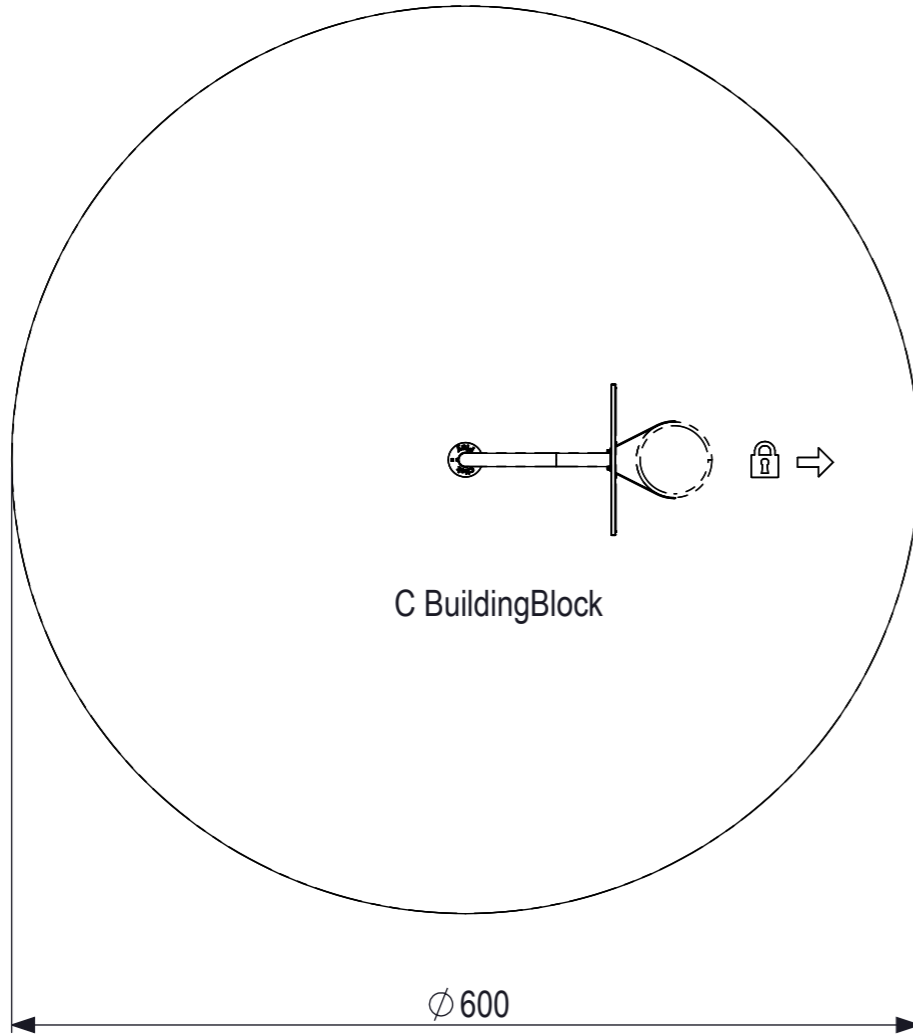

Plaatsing volgens NEN-EN 1176 blijft van kracht.

 IJSLANDER Ijlander BV Oude Dijk 10 8096 RK Oldebroek The Netherlands T +31 (0)525 633420 F +31 (0)525 631067 info@ijlander.com www.ijlander.com	oppervlakte ruwheid surface roughness DIN ISO 1302		alg. ruwheid gen. roughness 3.2	eenheid/unit cm	datum date 22-12-2017	naam name TB																							
	vorm- en plaatstoleranties geometrical tolerancing DIN ISO 1101		norm EN 15312:2007	toelaatbare afwijkingen voor lineaire maten (m.u.v. gebroken kanten) admissible deviations for linear dimensions (excepting broken edges)																									
alg. toleranties gen. tolerancing DIN 7168-m	<table border="1"> <tr> <td>lineaire maat linear dimension</td> <td>></td> <td>0,5</td> <td>6</td> <td>30</td> <td>120</td> <td>400</td> <td>1000</td> <td>2000</td> <td>4000</td> </tr> <tr> <td>afwijking/deviation</td> <td>≤</td> <td>±0.1</td> <td>±0.2</td> <td>±0.3</td> <td>±0.5</td> <td>±0.8</td> <td>±1.2</td> <td>±2</td> <td>±3</td> </tr> </table>			lineaire maat linear dimension	>	0,5	6	30	120	400	1000	2000	4000	afwijking/deviation	≤	±0.1	±0.2	±0.3	±0.5	±0.8	±1.2	±2	±3	Totaal gewicht: 60395.45 kg Zwaarste onderdeel: 38 kg	Leeftijd van: 5 - 99 jaar Valondergrond klasse:	tekeningnummer/drawingnumber CP-1180A-INS	blad/sheet 4 - 4	wijz./rev. 01	form./size A3
lineaire maat linear dimension	>	0,5	6	30	120	400	1000	2000	4000																				
afwijking/deviation	≤	±0.1	±0.2	±0.3	±0.5	±0.8	±1.2	±2	±3																				